



# PARÇA KATALOĞU

[www.kursunarms.com](http://www.kursunarms.com)



KS 001



KS 003



KS 005



KS 007



KS 009



KS 011



KS 013



KS 002



KS 004



KS 006



KS 008



KS 010



KS 012



KS 014

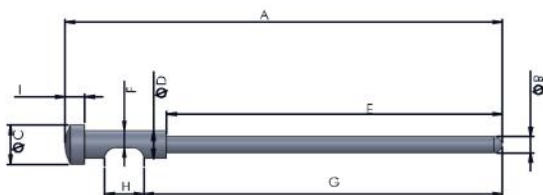

KOD	A	B	C	D	E	F	G	H	I
KS001	91,5 mm	1,6 mm	6,5 mm	7,6 mm	76 mm	3,8 mm	-	10 mm	2,8 mm
KS002	79 mm	2,8 mm	6,4 mm	-	-	4,3 mm	61 mm	-	-
KS003	78 mm	2,25 mm	2,8 mm	5,5 mm	70 mm	-	-	-	-
KS004	76 mm	2,9 mm	9 mm	7,45 mm	56,6 mm	4,55 mm	63,7 mm	9,5 mm	3,1 mm
KS005	87 mm	2,1 mm	6,8 mm	-	75 mm	4 mm	76,3 mm	6 mm	-
KS006	98,3 mm	2,3 mm	6,9 mm	5,8 mm	81 mm	3,7 mm	83 mm	10,5 mm	5,2 mm
KS007	97,3 mm	2,3 mm	6,9 mm	5,8 mm	81 mm	3,3 mm	82,9 mm	10,5 mm	3,9 mm
KS008	99,8 mm	2,3 mm	5,9 mm	-	74,5 mm	3,35 mm	76,9 mm	11 mm	11,8 mm
KS009	96,5 mm	2,3 mm	6,7 mm	5,85 mm	79,8 mm	4,4 mm	82,3 mm	10 mm	4,6 mm
KS010	76,6 mm	2,4 mm	7 mm	5,9 mm	64,2 mm	3,7 mm	66 mm	6 mm	1,3 mm
KS011	77 mm	2,85 mm	7 mm	4,85 mm	60,4 mm	3 mm	63,2 mm	7 mm	3,2 mm
KS012	77 mm	2,9 mm	7 mm	4,9 mm	59,6 mm	3 mm	63,2 mm	7 mm	3 mm
KS013	86,5 mm	2,85 mm	7 mm	4,85 mm	57,6 mm	3 mm	63,2 mm	7 mm	6,5 mm
KS014	85,5 mm	2,85 mm	7 mm	4,9 mm	59 mm	3 mm	63,2 mm	7 mm	5 mm



KS 015



KS 016



KS 017



KS 018



KS 019



KS 020



KS 021



KS 022



KS 023



KS 024



KS 025



KS 026



KS 027



KS 028



KS 029



KS 030

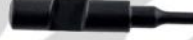

KS 031



KS 032



KS 033



KS 034



KS 035



KS 036

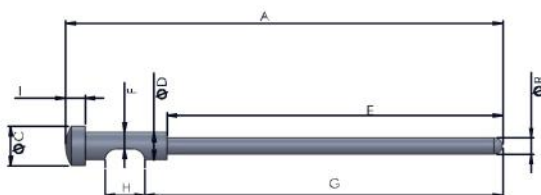

KOD	A	B	C	D	E	F	G	H	I
KS 015	78 mm	2,9 mm	7 mm	4,85 mm	59 mm	3 mm	63,2 mm	7 mm	3,3 mm
KS 016	86,9 mm	2,85 mm	7 mm	4,85 mm	57,8 mm	3 mm	63,2 mm	7 mm	4 mm
KS 017	84 mm	2,85 mm	7 mm	5,3 mm	71,4 mm	3 mm	75 mm	6 mm	3,5 mm
KS 018	89,4 mm	2,8 mm	6 mm	4,7 mm	67,4 mm	2,9 mm	72,6 mm	7 mm	8,5 mm
KS 019	90,5 mm	2,9 mm	7 mm	5,8 mm	70,5 mm	3,4 mm	74,5 mm	7 mm	6,5 mm
KS 020	87,6 mm	2,9 mm	7 mm	4,9 mm	60 mm	3 mm	63,2 mm	7 mm	7,5 mm
KS 021	25,3 mm	2,2 mm	4,45 mm	7,85 mm	16 mm	-	19,5 mm	-	-
KS 022	28,8 mm	2,2 mm	4,45 mm	7,85 mm	16 mm	-	20 mm	-	-
KS 023	35,6 mm	2,5 mm	6 mm	6 mm	20 mm	2,9 mm	24 mm	6,5 mm	5,4 mm
KS 024	33,4 mm	2,5 mm	6 mm	-	3 mm	-	27,8 mm	-	-
KS 025	34,5 mm	2,5 mm	6 mm	-	3 mm	-	28,8 mm	-	-
KS 026	38 mm	2,5 mm	6 mm	6 mm	15,3 mm	-	-	-	-
KS 027	32,4 mm	2,4 mm	6 mm	-	15,4 mm	3 mm	23,3 mm	6 mm	-
KS 028	34,4 mm	2,4 mm	6 mm	-	15,5 mm	3 mm	21,6 mm	8 mm	-
KS 029	22,9 mm	2,85 mm	6 mm	6 mm	9,8 mm	2,9 mm	12,15 mm	6 mm	6 mm
KS 030	33,7 mm	2,3 mm	6 mm	-	12,2 mm	3,2 mm	20 mm	6 mm	-
KS 031	33,9 mm	2,3 mm	6 mm	-	12,3 mm	3,2 mm	22,4 mm	6 mm	-
KS 032	20,5 mm	2,3 mm	4,9 mm	5,9 mm	11,5 mm	-	13,3 mm	-	-
KS 033	33 mm	2,4 mm	8 mm	6 mm	11,4 mm	2,8 mm	23,5 mm	5,8 mm	4 mm
KS 034	37 mm	2,4 mm	8 mm	5,9 mm	14 mm	3,8 mm	28 mm	6 mm	3,7 mm
KS 035	20 mm	2,9 mm	3,6 mm	4,9 mm	8,3 mm	-	10 mm	-	-
KS 036	37 mm	2,5 mm	5 mm	-	9,8 mm	2,8 mm	26,8 mm	5,8 mm	5,8 mm





KS 051



KS 052



KS 053



KS 054



KS 055



KS 056



KS 057



KS 058



KS 059



KS 060



KS 061



KS 062



KS 063



KS 064



KS 065



KS 066



KS 067



KS 068



KS 069



KS 070



KS 071



KS 072



KS 073



KS 074



KS 075



KS 076



KS 077



KS 078



KS 079



KS 080



KS 101



KS 102



KS103



KS104



KS105



KS 106



KS 107



KS 108



KS 109



KS110



KS111



KS112



KS 113



KS 114



KS 115



KS 116



KS1107



KS118

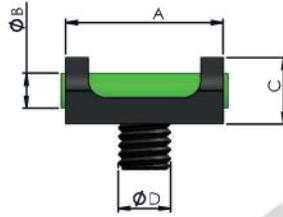

KOD	A	B	C	D	E
KS101	9 mm	2 mm	3,5 mm	m3	3,8 mm
KS102	9 mm	2 mm	3,5 mm	m3	3,8 mm
KS103	4,4 mm	2 mm	3,5 mm	m3	2,9 mm
KS104	4,4 mm	2 mm	3,5 mm	m3	2,9 mm
KS105	11,4 mm	2 mm	3,3 mm	m3	3,3 mm
KS106	11,4 mm	2 mm	3,3 mm	m3	3,3 mm
KS107	9,7 mm	3 mm	3,85 mm	m3	4 mm
KS108	9,2 mm	2,5 mm	3,4 mm	m3	3,6 mm
KS109	9,7 mm	3 mm	3,85 mm	m3	4 mm
KS110	9,2 mm	2,5 mm	3,4 mm	m3	3,6 mm
KS111	5,6 mm	3 mm	3,7 mm	m3	4,2 mm
KS112	5,6 mm	3 mm	3,7 mm	m3	4,2 mm
KS113	5,6 mm	2,5 mm	3,5 mm	m3	3,3 mm
KS114	9,2 mm	2,5 mm	3,4 mm	m3	3,6 mm
KS115	7 mm	1 mm	2,8 mm	m3	7 mm
KS116	10 mm	3 mm	6 mm	m3	3,9 mm
KS117	9 mm	2 mm	3,5 mm	m2,5	3,8 mm
KS118	8 mm	2 mm	5,9 mm	m3	3,5 mm



KS 120



KS 121



KS 122



KS 123



KS 124



KS 125

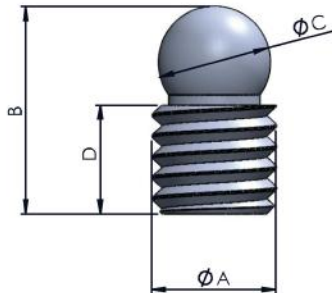

KOD	A	B	C	D
KS120	m3	6 mm	3 mm	2,5 mm
KS121	m3	6 mm	3 mm	2,5 mm
KS122	m3	5,9 mm	2,5 mm	2,5 mm
KS123	m3	5,9 mm	2,5 mm	2,5 mm
KS124	m4	6 mm	3 mm	2,5 mm
KS125	m2,5	6 mm	3 mm	2,5 mm



KS 127



KS 128



KS 129



KS 130



KS 131



KS 132



KS 133



KS 134



KS 135



KS 136



KS 137



KS 138



KS 139



KS 140



KS 141



KS 142



KS 143



KS 144



KS 145



KS 146



KS 147



KS 148



KS 149





KS 150



KS 151



KS 152



KS 153



KS 154



KS 155



KS 156



KS 157



KS 158



KS 159



KS 160



KS 161



KS 162



KS 163



KS 164



KS 165



KS 166



KS 167



KS 168



KS 169



KS 170



KS 171



KS 172



KS 173



KS 174



KS 175



KS 176





KS 185



KS 186



KS 187



KS 188



KS 189



KS 190



KS 191



KS 192



KS 193



KS 194



KS 195



KS 196



KS 197



KS 198



KS 199



KS 200



KS 201



KS 202



KS 203



KS 204



KS 205



KS 206



KS 207



KS 208



KS 209



KS 210



KS 211



KS 212



KS 213



KS 214



KS 215



KS 216



KS 217



KS 218



KS 219



KS 220



KS 221



KS 222



KS 223



KS 224



KS 225



KS 226



KS 227



KS 228



KS 229



KS 230



KS 231



KS 232



KS 240



KS 241



KS 242



KS 243



KS 244



KS 245



KS 246



KS 247



KS 248



KS 249



KS 250



KS 251



KS 252



KS 253



KS 254



KS 260



KS 261



KS 262



KS 263



KS 264



KS 265



KS 266



KS 267



KS 2628



KS 269



KS 270





KS 275



KS 276



KS 277



KS 278



KS 279



KS 280



KS 281



KS 282



KS 283



KS 284



KS 285



KS 286



KS 287



KS 288



KS 289



KS 290



KS 291



KS 292



KS 293



KS 294



KS 295



KS 296



KS 297



KS 298



KS 299



KS 300



KS 301



KS 302



KS 303



KS 304



KS 305



KS 306



KS 307



KS 308



KS 309



KS 310



KS 311



KS 312



KS 313



KS 314





KS 320



KS 321



KS 322



KS 323



KS 324



KS 325



KS 326



KS 327



KS 328



KS 329



KS 330





KS 335



KS 336



KS 337



KS 338



KS 339



KS 340



KS 341



KS 342



KS 343



KS 344



KS 345



KS 346



KS 347



KS 348



KS 349



KS 350



KS 351



KS 352



KS 353



KS 354



KS 355



KS 356



KS 357



KS 358



KS 359



KS 360



KS 361



KS 362



KS 363



KS 364



KS 365



KS 366



KS 367



KS 368



KS 369



KS 370



KS 371



KS 372



KS 373



KS 374



KS 375



KS 385



KS 386



KS 387



KS 388



KS 389



KS 390



KS 391



KS 392



KS 393



KS 394



KS 395



KS 396



KS 397



KS 398



KS 399



KS 400



KS 401



KS 402



KS 403



KS 404



KS 405



KS 406



KS 407



KS 408



KS 409



KS 410



KS 411



KS 412



KS 413



KS 414



KS 415



KS 416



KS 417



KS 418



KS 419



KS 420



KS 421



KS 422



KS 423



KS 424



KS 425



KS 426



KS 427



KS 428



KS 429



KS 430



KS 431



KS 432



KS 433



KS 434



KS 435



KS 436



KS 437



KS 438



KS 439



KS 440



KS 441



KS 442



KS 443



KS 444



KS 445



KS 446



KS 447



KS 448



KS 449



KS 450



KS 451



KS 452



KS 453



KS 454





KS 455



KS 456



KS 457



KS 458



KS 459



KS 460



KS 461



KS 462



KS 463



KS 464



KS 465



KS 466



KS 467



KS 468



KS 469



KS 470



KS 471



KS 472



KS 473



KS 474



KS 475



KS 476



KS 477



KS 478



KS 479



KS 480



KS 481



KS 482

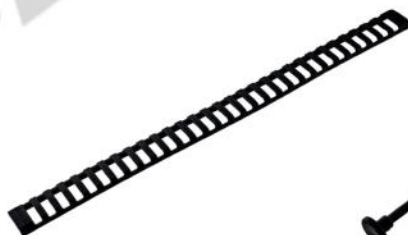

KS 483

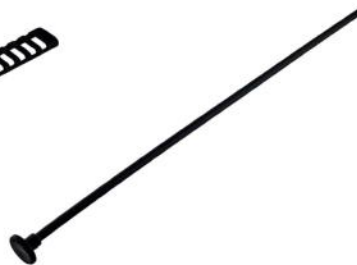

KS 484



KS 485



KS 486



KS 487



KS 500



KS 501



KS 502



KS 503



KS 504



KS 505



KS 506



KS 507



KS 508



KS 509



KS 510



KS 511



KS 515



KS 516



KS 517



KS 518



KS 519



KS 520



KS 521



KS 522



KS 523



KS 525



KS 526



KS 528



KS 529



KS 530



KS 531



KS 532



KS 533



KS 534



KS 535





KS 536



KS 537



KS 538



KS 539



KS 540



KS 541



KS 542



KS 543



KS 544



KS 545



KS 546



KS 547



KS 548



KS 549



KS 550



KS 551



KS 552



KS 553



KS 554



KS 555



KS 556



KS 557



KS 558



KS 559



	KOD	A	B	C	D	E	F
	KS 565	m8	5,8 mm	3,7 mm	-	-	0,9 mm
	KS 566	m3	5 mm	3,6 mm	5,5 mm	1,4 mm	y
	KS 567	m4	7,8 mm	5 mm	10 mm	2 mm	-
	KS 568	m8 (0,75)	6,5 mm	3,9 mm	9,8 mm	1,7 mm	-
	KS 569	m9 (0,75)	7,5 mm	3,9 mm	10,5 mm	2,5 mm	-
	KS 570	m4	6 mm	3 mm	6 mm	2,3 mm	0,9 mm
	KS 571	1/8	7 mm	5 mm	4 mm	2 mm	0,5 mm
	KS 572	m7	6,4 mm	6,4 mm	-	-	0,9 mm
	KS 573	m8	7,9 mm	4 mm	13,8 mm	1,9 mm	-
	KS 574	m3	6,8 mm	4 mm	8 mm	2,8 mm	0,8 mm
	KS 575	m8	6,9 mm	6,9 mm	-	-	0,9 mm
	KS 576	m4	7,4 mm	7,4 mm	8,3 mm	-	-
	KS 577	m5	6,3 mm	2,7 mm	9,8 mm	2,6 mm	0,9 mm
	KS 578	m4	6,5 mm	3,7 mm	6 mm	1,2 mm	0,9 mm
	KS 579	m4	7 mm	3,5 mm	10 mm	2 mm	0,9 mm
	KS 580	m5	7,8 mm	3,8 mm	6,8 mm	3 mm	1 mm
	KS 581	m4	8 mm	5 mm	5 mm	2,2 mm	0,6 mm
	KS 582	m3	6,8 mm	2,8 mm	8 mm	2,5 mm	0,8 mm
	KS 583	m4	7,9 mm	4 mm	7 mm	2,6 mm	1 mm
	KS 584	m4	8,3 mm	5,3 mm	8 mm	1,6 mm	0,9 mm
	KS 585	m3	10 mm	7,5 mm	5,4 mm	0,8 mm	1 mm
	KS 586	m3,5	10 mm	5,5 mm	7 mm	2 mm	0,8 mm
	KS 587	m3,5	10 mm	5,5 mm	7 mm	1,6 mm	0,8 mm
	KS 588	m4	10 mm	6 mm	7 mm	2,7 mm	0,9 mm
	KS 589	m3,5	10 mm	5,4 mm	6,9 mm	2,3 mm	0,9 mm
	KS 590	m5	10 mm	5 mm	5 mm	-	0,8 mm
	KS 591	m5	7,7 mm	7,7 mm	9 mm	2,75 mm	1 mm
	KS 592	m3	5 mm	5 mm	4 mm	1,5 mm	0,6 mm
	KS 593	m3,5	6,8 mm	6,8 mm	6,7 mm	2,7 mm	0,8 mm

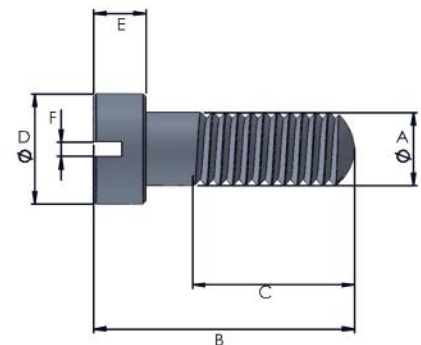





	KOD	A	B	C	D	E	F
	KS 594	m3	11,8 mm	7 mm	6 mm	2,6 mm	0,8 mm
	KS 595	m4	12 mm	9,9 mm	6,4 mm	2,5 mm	1 mm
	KS 596	m4	14 mm	7,5 mm	8 mm	2,5 mm	1 mm
	KS 597	m19	10,6 mm	5 mm	22 mm	1,5 mm	1,5 mm
	KS 598	m14	13,2 mm	7,5 mm	16 mm	3 mm	-
	KS 599	m8 m17	54 mm	6,5 mm 26,8 mm	19 mm	3,5 mm	3,5 mm
	KS 600	m4	14 mm	8,3 mm	6 mm	3 mm	0,8 mm
	KS 601	m5	14,3 mm	8 mm	6,8 mm	5 mm	30a
	KS 602	m4	14,9 mm	12 mm	6 mm	2 mm	0,6 mm
	KS 603	m4	14 mm	10,5 mm	7 mm	3,3 mm	1 mm
	KS 604	m4	13 mm	9,5 mm	7 mm	3,3 mm	1 mm
	KS 605	ø4,60mm	16,9 mm	1,6 mm	6,85 mm	2,4 mm	0,9 mm
	KS 606	m4	18,4 mm	5 mm	7 mm	1,8 mm	0,8 mm
	KS 607	m8	43 mm	34 mm	7,8 mm	7,8 mm	60a
	KS 608	m5	29,8 mm	14,3 mm	8 mm	2,7 mm	1
	KS 609	ø6 mm	27 mm	19,4 mm	9 mm	3 mm	1
	KS 610	ø4,8 mm	32 mm	28 mm	9,4 mm	3 mm	y
	KS 611	m5	4 mm	8,9 mm	8 mm	1,5 mm	0,9 mm
	KS 612	m4	43,8 mm	9 mm	8 mm	1,9 mm	0,9 mm
	KS 613	m6	40 mm	12 mm	8 mm	2 mm	1 mm
	KS 614	m4	40 mm	7,5 mm	5 mm	4,3 mm	0,6 mm
	KS 615	m8	50 mm	20 mm	19 mm	3 mm	-

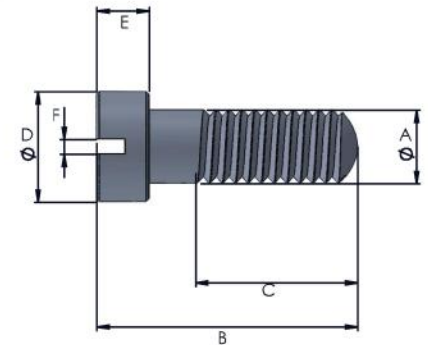



























KOD	A	B	C	D	E	F
<b>KS 616</b>	m8	125,5 mm	23,5 mm	-	5,6 mm	13a

KOD	A	B	C	D	E	F
<b>KS 617</b>	m6	140 mm	36,5 mm	-	5,5 mm	12a

KOD	A	B	C	D	E	F
<b>KS 618</b>	m8	208 mm	48 mm	-	6,7 mm	13a



	KOD	A	B	C
	KS 625	11 mm	3,9 mm	0,6 mm
	KS 626	11 mm	2,9 mm	0,5 mm
	KS 627	12,2 mm	4,7 mm	0,5 mm
	KS 628	13,3 mm	4,8 mm	0,6 mm
	KS 629	26 mm	21,6 mm	2,5 mm
	KS 630	13,4 mm	8,6 mm	0,75 mm
	KS 631	27 mm	13,6 mm	3,5 mm
	KS 632	17 mm	4,3 mm	0,4 mm
	KS 633	19,5 mm	4 mm	0,5 mm
	KS 634	18 mm	4,4 mm	0,5 mm
	KS 635	21,5 mm	4,5 mm	0,5 mm
	KS 636	18,3 mm	3,9 mm	0,5 mm
	KS 637	20 mm	2,9 mm	0,4 mm
	KS 638	23 mm	2,9 mm	0,5 mm
	KS 639	25,5 mm	3,9 mm	0,5 mm
	KS 640	25 mm	7 mm	0,8 mm
	KS 641	-	-	0,7 mm
	KS 642	-	-	0,7 mm
	KS 643	-	-	0,7 mm
	KS 644	-	-	1 mm
	KS 645	-	23 mm	1,8 mm
	KS 646	-	31,2 mm	1,9 mm
	KS 647	-	-	1,2 mm
	KS 648	-	-	1 mm
	KS 649	-	-	1,1 mm
	KS 650	-	-	-

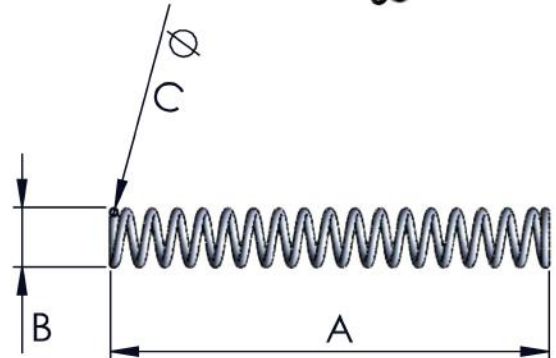



	KOD	A	B	C
	KS 651	36 mm	4,8 mm	0,5 mm
	KS 652	44,4 mm	3,7 mm	0,65 mm
	KS 653	44,3 mm	6,5 mm	0,7 mm
	KS 654	51,5 mm	7,9 mm	1,1 mm
	KS 655	53,5 mm	7,9 mm	1,1 mm
	KS 656	60,5 mm	4,6 mm	0,6 mm
	KS 657	65,5 mm	14,3 mm	1,3 mm
	KS 658	-	10 mm 23 mm	1 mm
	KS 659	-	12 mm 20,5 mm	1 mm
	KS 660	18 Siper	29,5 mm	1,7 mm
	KS 661	-	19,5 mm	1,5 mm

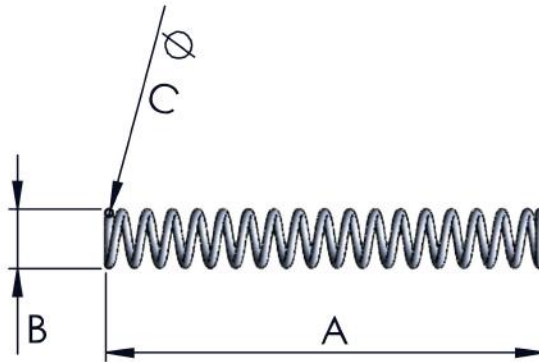



	KOD	A	B	C
	KS 665	-	-	1,8 mm
	KS 666	-	-	1,8 mm
	KS 667	-	-	1,8 mm
	KS 668	-	-	1,9 mm
	KS 669	-	21 mm	3,6 mm
	KS 670	-	-	1,1 mm
	KS 671	-	19,5 mm	1,1 mm
	KS 672	-	-	1,8 mm
	KS 673	160 mm	29,5 mm	0,7 mm
	KS 674	-	29,5 mm	1,9 mm

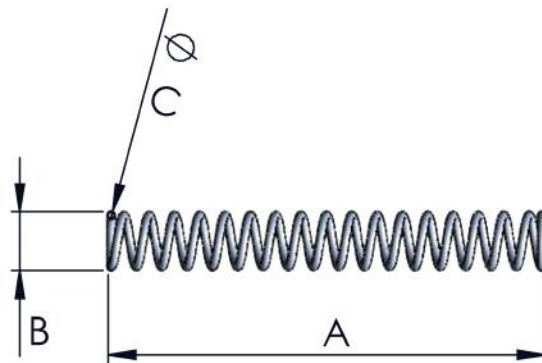



KS 001	SAFİR İĞNE
KS 002	POMPALI İĞNE
KS 003	OTOMATİK İĞNE
KS 004	İĞNE
KS 005	36 CAL İĞNE
KS 006	KİNETİK UZUN İĞNE
KS 007	KİNETİK İĞNE
KS 008	BENELLİ İĞNE
KS 009	KİNETİK İĞNE
KS 010	OTO İĞNE
KS 011	KISA KADEMELİ İĞNE
KS 012	OTO KISA İĞNE
KS 013	OTO UZUN İĞNE
KS 014	KADEMELİ UZUN İĞNE
KS 015	KADEMELİ KISA İĞNE
KS 016	OTO UZUN İĞNE
KS 017	OTO İĞNE
KS 018	İĞNE
KS 019	OTO İĞNE
KS 020	ŞARJÖRLÜ İĞNE
KS 021	POZE İĞNE ALT
KS 022	POZE İĞNE ÜST
KS 023	POZE İĞNE
KS 024	İĞNE ALT
KS 025	İĞNE ÜST
KS 026	TASARLANMIŞ POZE İĞNE
KS 027	POZE İĞNE ALT
KS 028	POZE İĞNE ÜST
KS 029	TEK İĞNE
KS 030	POZE İĞNE ALT
KS 031	POZE İĞNE ÜST
KS 032	GİZLİ HOROZ TEK İĞNE
KS 033	ESKİ ÜZÜMLÜ POZE İĞNE ALT
KS 034	ESKİ ÜZÜMLÜ POZE İĞNE ÜST
KS 035	ÇAKMAKLI İĞNE
KS 036	ÇİFT KIRMA İĞNE
KS 051	ALM. KURMA KOLU
KS 052	ALM. KURMA KOLU KISA
KS 053	KİNETİK KURMA KOLU
KS 054	KİNETİK KURMA KOLU
KS 055	KİNETİK KURMA KOLU ÖZEL
KS 056	KİNETİK KURMA KOLU YUVARLAK
KS 057	KİNETİK KURMA KOLU YUVARLAK
KS 058	KURMA KOLU
KS 065	KURMA KOLU BEYAZ
KS 066	YUVARLAK KURMA KOLU
KS 067	YUVARLAK KURMA KOLU
KS 068	DÖKÜM KURMA KOLU

KS 069	PLS KURMA KOLU
KS 070	DELİKLİ KURMA KOLU
KS 071	DELİKLİ KURMA KOLU
KS 072	GAZLI KURMA KOLU
KS 073	GAZLI KURMA KOLU
KS 074	GAZLI KURMA KOLU
KS 075	GAZLI KURMA KOLU NİKEL
KS 076	ESKİ GAZLI KURMA KOLU
KS 077	GAZLI KURMA KOLU 6 KÖŞE
KS 078	GAZLI K. KOLU FREZELİ LÜX
KS 079	ÇİFT YÖN YUVARLAK GAZLI K. KOLU
KS 150	DÖKÜM AĞAÇ KAYIŞLIK
KS 151	DÖKÜM UZUN
KS 152	DÖKÜM KISA
KS 153	DÖKÜM HALKA
KS 154	TEL AĞAÇ KAYIŞLIK
KS 155	TEL UZUN KAYIŞLIK
KS 156	TEL ORTA KAYIŞLIK
KS 157	TEL KISA
KS 158	TEL PERÇİN
KS 159	TEL 3,16 DIŞ
KS 160	TEL SARI KAYIŞLIK
KS 161	S. POZE KAYIŞLIK
KS 162	ÇİFTE KAYIŞLIK
KS 163	LÜX POZE KAYIŞLIK 12 CAL
KS 164	LÜX POZE KAYIŞLIK 36 CAL
KS 165	POZE KAYNAKLI KAYIŞLIK TAKIMI
KS 166	LÜX KAYIŞLIK
KS 167	LÜX KAYIŞLIK AĞAÇ
KS 168	LÜX AĞAÇ UÇ
KS 169	LÜX UÇ
KS 170	BİLYELİ KAYIŞLIK
KS 171	ŞARJÖRLÜ KAYIŞLIK
KS 172	7+1 SAÇ KAYIŞLIK
KS 173	KAPAKLI HALKA SAÇ KAYIŞLIK
KS 174	LÜX KAYIŞLIK
KS 175	GENİŞ HALKA KAYIŞLIK
KS 176	AĞAÇ KAYIŞLIK GENİŞ HALKA
KS 185	POMPALI KASA PİMİ KOVANI
KS 186	OTO KASA PİMİ KOVANI
KS 187	POMPALI HOROZ KOVANI
KS 188	OTO HOROZ KOVANI
KS 189	ATBAŞI KOVANI DÜZ
KS 190	ATBAŞI KOVANI YUVARLAK
KS 191	İÇ EMNİYET KOVANI
KS 192	EMNİYET KOVANI UZUN
KS 193	EMNİYET KOVANI ORTA
KS 194	EMNİYET KOVANI KISA



KS 195	POZE KELEBEK KOVANI
KS 196	ŞARJÖRLÜ HOROZ BURCU TAKIM
KS 197	TEK ANAVİDA 12 CAL
KS 198	TEK ANAVİDA 36 CAL
KS 199	TEK ANAVİDA KALIN
KS 200	POMPALI KASA PİMİ 5,5 MM
KS 201	OTO KASA PİMİ 4,5 MM
KS 202	OTO KASA PİMİ 4,5 MM
KS 203	HELİS PİMİ
KS 204	SAFİR T-14 HELİS PİMİ
KS 205	DÜŞÜRÜCÜ KISA
KS 206	DÜŞÜRÜCÜ UZUN
KS 207	SAK PİMİ
KS 208	ATBAŞI PİMİ
KS 209	GİZLİ HOROZ YAY PİMİ
KS 210	TETİK PİMİ
KS 211	TZ HOROZ PİMİ
KS 212	EMNİYET YUVARLAK
KS 213	ÜÇGEN EMNİYET
KS 214	ÜÇGEN EMNİYET ŞAPKALI
KS 215	ATBAŞI PERÇİNİ
KS 216	ATBAŞI PERÇİNİ
KS 217	İĞNE SAPLAMASI
KS 218	TIRNAK SAPLAMASI
KS 219	TEK NAMLU KAYIŞLIK SOMUNU
KS 220	KEP PERÇİNİ
KS 221	SAFİR KASA ÇİVİSİ UZUN
KS 222	SAFİR KASA ÇİVİSİ KISA
KS 223	VİDALI KASA PİMİ
KS 224	POZE YAY YUVASI
KS 225	İĞNE KAPAĞI
KS 226	OTO KAŞIK PİMİ
KS 227	BENELLİ İĞNE SAPLAMASI
KS 228	M LOCK SOMUN
KS 229	CIRCİR TÜPÜ
KS 230	POZE HOROZ YAYI MİLİ
KS 231	BENELLİ M4 KASA PİMİ
KS 232	G. HOROZ TEK HOROZ YAYI PİMİ
KS 249	AÇIK SOMUN UZUN
KS 250	KONTRA SOMUN
KS 251	KONTRA SOMUN BEYAZ
KS 252	UZUN KONTRA SOMUN
KS 253	BENELLİ SOMUN
KS 254	BENELLİ GENİŞ SOMUN
KS 260	DÜZ KİLİT 12 CAL
KS 261	DÜZ KİLİT 20 CAL
KS 262	İNCE BACAK KİLİT 12 CAL
KS 263	KİLİT 12 CAL

KS 264	KİLİT 20 CAL
KS 265	KİLİT 12 CAL
KS 266	KİLİT 20 CAL
KS 267	KİLİT 36 CAL
KS 268	TERS KİLİT
KS 269	TEK KIRMA KİLİT
KS 270	GİZLİ HOROZ TEK KİLİT
KS 275	ŞOK TAKIMI
KS 280	MOBİL ŞOK
KS 286	MOBİL ŞOK FREZELİ
KS 287	MOBİL ŞOK DELİKLİ
KS 288	36 CAL MOBİL ŞOK
KS 291	MOBİL APARAT
KS 305	ŞOK KAPAĞI
KS 320	2+1 ŞARJÖR BORUSU
KS 321	4+1 ŞARJÖR BORUSU
KS 322	4+1 ŞARJÖR BORUSU SOMUNLU
KS 323	4+1 ŞARJÖR BORUSU SOMUNSUZ
KS 324	4+1 KİNETİK Ş. BORUSU
KS 325	7+1 ŞARJÖR BORUSU SOMUNLU
KS 326	7+1 ŞARJÖR BORUSU SOMUNSUZ
KS 327	7+1 KİNETİK Ş. BORUSU
KS 335	ATBAŞI
KS 346	TEK HOROZ
KS 347	KİNETİK HOROZ
KS 348	KİNETİK HOROZ
KS 349	OTO-POMP HOROZ
KS 350	OTO-POMP HOROZ
KS 351	OTO HOROZ
KS 352	ŞARJÖRLÜ HOROZ
KS 353	POMPALI TETİK
KS 354	OTOMATİK TETİK
KS 356	TEK KIRMA TETİK
KS 357	GAZLI İÇ EMNİYET
KS 358	KİNETİK İCRA BORUSU MİLİ KISA
KS 359	KİNETİK İCRA BORUSU MİLİ UZUN
KS 360	İCRA BORUSU MİLİ
KS 361	KİNETİK FİŞEK ATTIRICI
KS 362	OTO DÜĞME KISA
KS 363	OTO DÜĞME UZUN
KS 364	KÖŞELİ DÜĞME
KS 365	OTO DÜĞME TAKIM
KS 366	POMP TUTUCU TAKIMI
KS 367	OTO TUTUCU TAKIMI
KS 368	ÇİFT DÜĞME
KS 369	POMP TUTUCU
KS 370	POMP DÖKÜM TUTUCU
KS 371	KİNETİK DÜŞÜRÜCÜ SAC

KS 372	POMP ÇİFT TUTUCU SAC
KS 373	OTO DÜŞÜRÜCÜ SAC
KS 374	TZ PARÇA
KS 375	ESKİ KİNETİK SAÇ PARÇA
KS 385	OTO TIRNAK
KS 386	OTO TIRNAK KISA
KS 387	KİNETİK KIRNAK
KS 388	TIRNAK
KS 389	POMPALI HALKA
KS 390	KİNETİK HALKA
KS 391	POZE EL KUNDAK KİLİDİ
KS 392	POZE EL KUNDAK KALDIRAÇ
KS 393	POZE EL KUNDAK KİLİT
KS 394	POZE EMNİYET
KS 395	POMPALI MAŞA YAY
KS 396	OTO MAŞA YAY
KS 400	KİNETİK ÇATAL
KS 401	ÇATAL
KS 402	TEK KIRMA ÇATAL
KS 403	ŞARJÖRLÜ MANDALI
KS 404	ÇİFT TETİK POZE KORKULUK
KS 405	TEK TETİK POZE KORKULUK
KS 406	TEK KORKULUK
KS 407	36-9 MM İNVERTÖR
KS 408	9-6 MM İNVERTÖR
KS 409	ALM. TAPA UZUN
KS 410	ALM. TAPA KISA
KS 411	PLASTİK TAPA ÖN
KS 412	PLASTİK TAPA ARKA
KS 413	MAŞA YAY
KS 423	DEMİR TAPA ALT
KS 424	KİNETİK Ş. BORUSU TAPA
KS 425	ŞARJ. BORUSU TIRNAĞI DEMİR
KS 426	ŞARJ. BORUSU TIRNAĞI PLS
KS 427	SAC TAPA
KS 428	POMPALI DÜŞÜRÜCÜ
KS 429	KAŞIK
KS 434	KOL BORUSU ORTA
KS 435	KOL BORUSU KISA
KS 436	KOL BORUSU ORTA
KS 437	KOL BORUSU UZUN
KS 438	KOL BORUSU DEMİR UZUN
KS 439	KOL BORUSU DEMİR KISA
KS 440	POMP. KOL BORUSU DEMİR UZUN
KS 441	TAŞIYICI
KS 442	İCRA BORUSU
KS 443	KİNETİK İCRA BORUSU
KS 444	OTO MEKANİZMA YANAKLI DOLU

KS 445	OTO MEKANİZMA YANAKLI DOLU
KS 446	OTO MEKANİZMA DOLU
KS 447	POMP. MEKANİZMA DOLU
KS 448	ŞARJÖRLÜ MEKANİZMA
KS 449	MEKANİZMA
KS 450	KİNETİK MEKANİZMA TAKIM
KS 451	KİNETİK MEKANİZMA
KS 452	KİNETİK MEKANİZMA
KS 453	KİNETİK MEKANİZMA
KS 454	DÖNER KAFA
KS 455	KİNETİK KEP
KS 456	KISA KEP
KS 457	GAZLI- POMP KEP
KS 458	KOL
KS 467	TETİK İÇ EMNİYET
KS 468	ÇİFT KIRMA TETİK KOLU YAYI
KS 469	BENELLİ M2 İCRA BORUSU İTİCİ MİLİ
KS 470	HALKA SEKMANLI PİSTON
KS 471	TEK KIRMA KORKULUK
KS 472	ARA TAKOZ UZUN
KS 473	ARA TAKOZ KISA
KS 474	EL KUNDAK ÜST PLASTİK
KS 475	EL KUNDAK ÜST PLASTİK
KS 476	EL KUNDAK ÜST PLASTİK
KS 478	HAVALI CONTA
KS 479	ÇEKME KOLU PLASTİĞİ
KS 480	GAZ ODASI ORLİK
KS 481	KUNDAK AYAR PULU
KS 482	ALT ÇATAL AYAK
KS 483	EL KUNDAK RAYI UZUN
KS 484	7+1 TAKOZ
KS 485	4+1 TAKOZ
KS 500	OTO KAPAK BOŞ
KS 501	KİNETİK KAPAK BOŞ
KS 502	KİNETİK KAPAK ALTTAN DÜŞÜRÜCÜ BOŞ
KS 503	KİNETİK KAPAK KOVANLI BOŞ
KS 504	POMPALI KAPAK BOŞ
KS 505	OTO KAPAK DOLU PLS.
KS 506	POMP. KAPAK ALTTAN DÜŞÜRÜCÜ DOLU PLS
KS 507	TZ Lİ KAPAK DOLU METAL
KS 508	TEK PİMİ ALTTAN DÜŞÜRÜCÜ DOLU PLS
KS 509	KİNETİK KAPAK YANDAN DÜŞÜRÜCÜ DOLU
KS 510	GİZLİ HOROZ TEK TETİK GRUBU PLS
KS 511	GİZLİ HOROZ TEK KAPAK DOLU
KS 515	BAKALİT
KS 526	OTO-POMP. PLS DİPÇİK
KS 528	KİNETİK PLS DİPÇİK
KS 529	OTO-POMP. PLS DİPÇİK SAPLI



KS 530	OTO-POMP. DİPÇİK FİŞEKLİKLİ
KS 531	TEK PLS DİPÇİK
KS 532	TELESKOBİK DİPÇİK
KS 533	KATLANIR DİPÇİK
KS 534	TELESKOBİK KABZA
KS 535	TABANCA KABZE
KS 536	OTO PLS EL KUNDAĞI
KS 537	OTO EL KUNDAĞI PİKATİNİLİ
KS 538	POMP KISA EL KUNDAK PLS
KS 539	POMP ORTA EL KUNDAK
KS 540	POMP UZUN EL KUNDAK
KS 541	POMP LÜX EL KUNDAK
KS 542	TEK EL KUNDAK PLS
KS 543	KİNETİK EL KUNDAK PLS
KS 544	OTO-POMP AĞAÇ DİPÇİK
KS 547	KİNETİK AĞAÇ DİPÇİK
KS 548	OTO-POMP DEKORLU AĞAÇ DİPÇİK
KS 549	TEK AĞAÇ DİPÇİK
KS 550	POZE AĞAÇ DİPÇİK
KS 552	POZE AĞAÇ EL KUNDAK
KS 553	POZE AĞAÇ EL KUNDAK
KS 554	OTO AĞAÇ EL KUNDAK
KS 557	ALT ÜST PLS AĞAÇ EL KUNDAK
KS 558	KİNETİK EL KUNDAK AĞAÇ
KS 559	TEK AĞAÇ EL KUNDAK
KS 565	ÖZEL VİDA
KS 566	POZE- ÇİFTE KAYIŞLIK VİDASI
KS 567	SOMUN
KS 568	İĞNE KAPAĞI
KS 572	BASINÇ VİDASI
KS 573	İĞNE KAPAĞI
KS 574	ÖZEL VİDA
KS 575	BASINÇ VİDASI
KS 576	EL KUNDAK TIRTIRLI SOMUN
KS 595	TEK KIRMA YAY VİDASI
KS 596	TEK KIRMA KORKULUK VİDASI
KS 597	KİNETİK KASA VİDASI
KS 598	KİNETİK İCRA BORU VİDASI
KS 599	İCRA BORUSU SOMUNU
KS 616	OTO PLS DİPÇİK VİDASI
KS 617	POZE DİPÇİK VİDASI
KS 618	OTO AĞAÇ DİPÇİK VİDASI
KS 625	BİLYE YAYI
KS 626	GEZ YAYI
KS 627	TEK İĞNE YAYI
KS 628	DÜĞME YAYI
KS 629	TAHLİYE YAYI
KS 630	YAN PARÇA YAYI

KS 631	KİNETİK TAKOZ YAYI
KS 632	DÜŞÜRÜCÜ YAYI
KS 633	ŞARJÖRLÜ İĞNE YAYI
KS 634	TZ KAPAK YAYI
KS 635	TETİK YAYI
KS 636	İÇ EMNİYET YAYI
KS 637	EMNİYET YAYI
KS 638	TIRNAK YAYI
KS 639	ŞAK PİM YAYI
KS 640	TEK KÜSÜ YAYI
KS 641	D SEKMAN
KS 642	D SEKMAN
KS 643	DÖKÜM TUTUCU YAYI
KS 644	POMP TETİK YAYI
KS 645	ŞARJ. PİSTON SEKMANI
KS 646	PİSTON SEKMANI
KS 647	KASA PİM SEKMANI
KS 648	TETİK YAYI
KS 649	HOROZ YAYI
KS 650	TEK HOROZ YAYI
KS 651	GERDEL YAYI
KS 652	ATBAŞI YAYI
KS 653	MANDAL YAYI
KS 654	POMP. HOROZ YAYI
KS 655	HOROZ YAYI
KS 656	İĞNE YAYI
KS 657	PCP TAKOZ YAYI
KS 658	TAB. ŞARJÖR YAYI
KS 659	TAB. ŞARJÖR YAYI
KS 660	İCRA YAYI
KS 661	ŞARJ. İCRA YAYI
KS 665	2 Lİ ŞARJÖR YAYI
KS 666	5 Lİ ŞARJÖR YAYI
KS 667	10 LU ŞARJÖR YAYI
KS 668	20 Lİ ŞARJÖR YAYI
KS 669	HAVALI YAY
KS 670	HAVALI YAY
KS 671	4+1 ŞARJÖR YAYI
KS 672	7+1 ŞARJÖR YAYI
KS 673	İCRA YAYI



**KURSUN**  
arms 